

Cat. No. 0743 Shower Door Latch Sets

Mounting Instructions

These latches are designed to be mounted through surfaces from 5/16 to 1/2 inches thick. Read all instructions before proceeding.

- 1) Refer to the exploded assembly drawing for the relative positioning of latch components that mount through the 7/8 inch diameter mounting hole.
- 2) The backset dimension (distance from the edge of the door to the center of the mounting hole) will vary based on whether the straight (180°) or angled (135°) cam bar and the hook or flat strike is being installed.
 - a) **For the 180° cam bar and the "J" hook strike**, the backset will be 2 inches minus the gap between the door edge and the door frame. This will allow the hook to be mounted approximately 1/8 inch away from the door frame.
 - b) **For the 180° cam bar and the flat strike**, the backset will be 2-3/8 inches minus the gap between the door edge and the door frame. This will allow the tip of the cam bar to enter the slot of the flat strike by over 1/4 inch.
 - c) **For the 135° cam bar and the "J" hook strike**, the backset will be approximately 2-9/32 inches minus the gap between the door edge and the door frame. Placement of the hook strike on an angled door frame surface must be accomplished by engaging all the components before determining the exact location of the 7/8 inch mounting hole.
- 3) At the determined location, drill a 7/8 inch diameter hole in the door.
- 4) Assemble the latch through the door, making sure the component with the 4 detent dimples is oriented so that the dimples are level (up/down and left/right).
- 5) Rotate the latch so that the cam bar is horizontal and in its detent. Now engage the strike plate or strike hook with the cam bar. Fasten it to the door frame, making sure the cam bar remains horizontal when fully engaged with the strike.

Fig 0743 Assembly Diagram

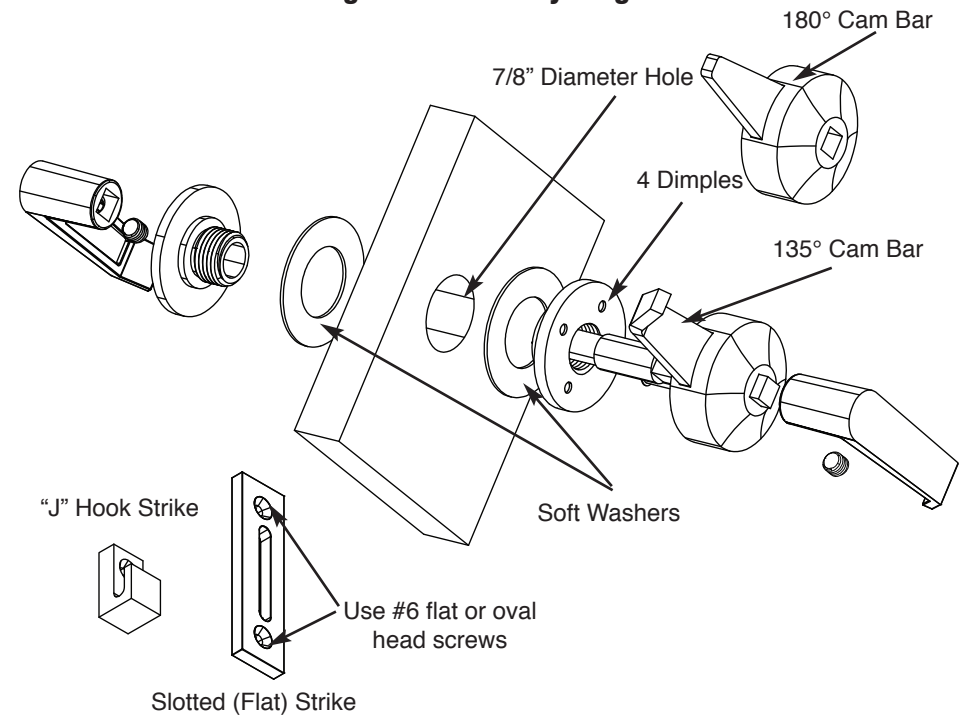

Fig. 0743 001 CHR
135° cam bar with
"J" hook strike



Fig. 0743 002 CHR
180° cam bar with
slotted strike



Fig. 0743 003 CHR
180° cam bar with
"J" hook strike

